

Data Sheet



Article number: 071101410340040

Description: Cardan drive shaft 0.110.141.002
S=340 X=40 Bore with keyway

Measures

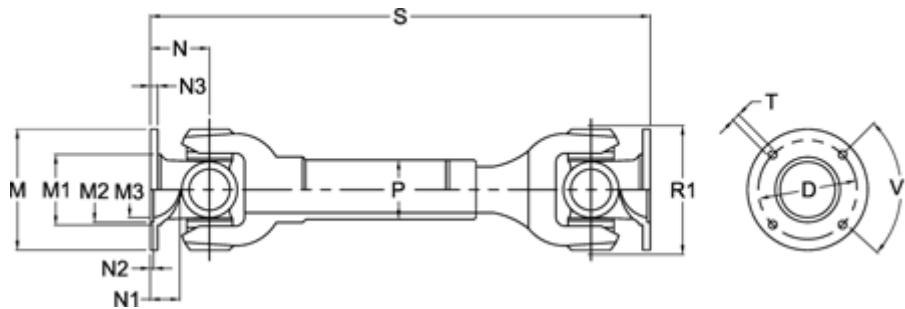

D	= 101,5 +-0,1	N1	= 22	T	= 8 B12
Extension X	= 40	N2	= 2,5 +0,5	V1 degrees	= 45
Flange diameter M	= 120	N3	= 8		
M1	= 80.5	Number of Flangeholes	= 8		
M2	= 75	P	= 50x3		
M3	= 61	R1	= 98		
Max. Bending Angle degrees	= 18	S min	= 340		
N	= 46	Spline dim. DIN 5480	= 35x2x16		